

aseXML SCHEMA CHANGE REQUEST

PREPARED BY: PIUS KURIAN, PAUL SPAIN

DOCUMENT REF: CR 39

VERSION: 1.1

DATE: 10 AUG 2010

DRAFT/FINAL DRAFT

Version Release History

Version	Date	By	Changes
1.0	21/06/2010	Pius Kurian, Paul Spain	High Speed Monitoring (HSM) additions: New transactions and supporting types, and deletion of existing TriggeredDataNotification Type.
1.1	10/08/2010	Pius Kurian, Paul Spain	Included changes suggested by ASWG. Modified to include 512 sized blocks.

Glossary

Abbreviation	Description

Contents

- 1 Change Proposal 4
 - 1.1 Description of the proposed change 4
 - 1.1.1 First change description 5
 - 1.2 Reason for Change 5
 - 1.3 Supplied Documents 5
 - 1.3.1 Business process document 5
 - 1.3.2 Other 5
 - 1.4 Baseline Schema 6
- 2 Approval Proposal 6
 - 2.1 Proposed Change #1 6
 - 2.1.1 Draft schema 6
 - 2.1.2 Change log 6
 - 2.1.3 Schema change description 7
 - 2.1.4 Impact Summary 25
 - 2.1.5 Developer Test 26
- 3 Proposal Assessment26
 - 3.1 Test 26
 - 3.1.1 Test Platforms 26
 - 3.1.2 Test Cases 26
 - 3.1.3 Test Results 26
 - 3.2 Conformance Report 27
- 4 Issue Register27
 - 4.1 Status of Issues 27
- 5 Resolution27
 - 5.1 ASWG Endorsement 27

1 Change Proposal

This Change Proposal is to include new as well as modified transaction types that have been identified for accomplishing business needs for delivering Triggered Data to Market Operator.

We are proposing to introduce new transactions to:

- 1) retrieve a listing of available triggered data
- 2) retrieve details of triggers

We are also proposing to modify existing transactions to:

- 3) retrieve triggered data
- 4) retrieve triggered monitor capability

1.1 Description of the proposed change

The proposed changes are listed in the following table.

Item#	Change Description	Change Type ¹
1	<p>Modified simple types: HSMQuantity, HSMDData</p> <p>Modified complex types: HSMMonitorData, HSMComtradeText , ElectricityHSMMonitorDataRequestData, ElectricityHSMMonitorDataResponseData, ElectricityHSMMonitorsRequestData, ElectricityHSMMonitorsResponseData</p> <p>Removed transaction: HSMTriggeredDataNotification</p> <p>Removed complex types: HSMTriggeredDataNotification, HSMTriggeredDataNotificationData</p>	Enhancement
	<p>New simple types: HSMTriggerID, HSMTriggerValue, HSMMonitors, HSMVendorSoftwareVersion</p> <p>New complex types: HSMTriggeredEvents, HSMTriggeredEvent, HSMTrigger, HSMTriggers, ElectricityHSMDataInventoryRequestData, ElectricityHSMDataInventoryResponseData, ElectricityHSMTriggersRequestData, ElectricityHSMTriggersResponseData, HSMContinuousMonitorData, HSMTriggeredMonitorData HSMDataInventoryRequest, HSMDataInventoryResponse, HSMTriggersRequest, HSMTriggersResponse, HSMDataInventoryRequestData, HSMDataInventoryResponseData, HSMTriggersRequestData, HSMTriggersResponseData</p> <p>New transactions: HSMDataInventoryRequest, HSMDataInventoryResponse,</p>	New

¹ Change Type can be one of

- New
- Enhancement, or
- Bug Fix

	HSMTriggersRequest, HSMTriggersResponse Removed transaction: HSMTriggeredDataNotification	
--	--	--

Table 1-1, Proposed Changes

1.1.1 First change description

TriggeredDataNotification is no longer used and hence the redundant HSMDData type has been removed from the Schema and HSMQuantity data type has been modified to identify and name the new quantities.

Several new Simple and Complex data types have been included to address several deficiencies identified in the current schema used in obtaining Triggered data.

1.2 Reason for Change

- 1) Vendors have highlighted there may be different channel configurations on the monitors for triggered and continuous data. Currently, there is an aseXML transaction, HSMMonitorCapability, designed to query and retrieve monitor configuration. This transaction was designed without the concept of multiple configurations for a given monitor. We will need to modify this transaction to support distinct configurations for continuous and triggered data.
- 2) The current aseXML schema has a closed set of 17 electrical quantities, HSMQuantity that can be recorded in monitor data messages. In the vendor document referring to quantities requested by VENCORP/AEMO, there are an additional six quantities listed: 3 x single phase currents, and 3 x phase-to-ground RMS currents. AEMO IT developers indicated there had been a further three quantities identified in discussion – 3 single phase current angles. The aseXML schema will need a modification to expand the HSMQuantity data type and to identify and name the new quantities.
- 3) Vendors have indicated that:
 - a. The ReplayPlus software can provide a directory listing of triggered data available for a specified time period, and
 - b. they will not provide any filtering of the triggered data

To better regulate the number of triggered data requests, and the amount of data returned, we need a new aseXML transaction to query and return portions of the directory information available on the ReplayPlus software. The requirements and constraints of this transaction will be determined in consultation with vendors and/or their representatives.
- 4) Vendors have mentioned a requirement to return a description of the triggering event with any triggered data. Following examination of sample DSM data, it is apparent we will need to modify the current aseXML triggered data response message to include the description of the triggering event. There is no provision in the COMTRADE Configuration or Data content, within the aseXML message, to include the trigger description.

1.3 Supplied Documents

1.3.1 Business process document

HSM business process documents are available on demand subject to AEMO management approval.

1.3.2 Other

aseXML_r26_Draft_zip

1.4 Baseline Schema

The schema used as a basis for this proposal is **aseXML_r25.xsd**.

2 Approval Proposal

2.1 Proposed Change #1²

2.1.1 Draft schema

Please refer to the schema files included with this proposal. The base schema is aseXML_r26 and one file has been modified as detailed in the next section.

2.1.2 Change log

The following changes have been implemented in this draft:

Chg #	Item #	Description of change	Filename
1	1	R26 namespace declaration and included files (r26 suffixes)	aseXML_r26.xsd
	2	New simple types: HSMTriggerID, HSMTriggerValue, HSMMonitors Modified simple types: HSMQuantity, HSMDData New complex types: HSMTriggeredEvents, HSMTriggeredEvent, HSMTrigger, HSMTriggers, ElectricityHSMDDataInventoryRequestData, ElectricityHSMDDataInventoryResponseData, ElectricityHSMTriggersRequestData, ElectricityHSMTriggersResponseData, HSMContinuousMonitorData, HSMTriggeredMonitorData Modified complex types: HSMMonitorData, HSMComtradeText , ElectricityHSMMonitorDataRequestData, ElectricityHSMMonitorDataResponseData, ElectricityHSMMonitorsRequestData, ElectricityHSMMonitorsResponseData	ElectricityHighSpeedMonitoring_r26.xsd
	3	New simple type: r26	Events_r26.xsd
	4	New simple type: HSMVendorSoftwareVersion New complex types: HSMDDataInventoryRequest, HSMDDataInventoryResponse, HSMTriggersRequest, HSMTriggersResponse, HSMDDataInventoryRequestData, HSMDDataInventoryResponseData, HSMTriggersRequestData, HSMTriggersResponseData Removed complex types: HSMTriggeredDataNotification, HSMTriggeredDataNotificationData	HighSpeedMonitoring_r26.xsd
	5	New transactions: HSMDDataInventoryRequest, HSMDDataInventoryResponse, HSMTriggersRequest, HSMTriggersResponse Removed transaction: HSMTriggeredDataNotification	Transactions_r26.xsd

Table 2-1 Change Log

² This section may be repeated if more than one option is considered

2.1.3 Schema change description

2.1.3.1 Retrieve a listing of available triggered data

The payload of the **HSMDDataInventoryRequest** transaction is the new data type **ElectricityHSMDDataInventoryRequestData**.

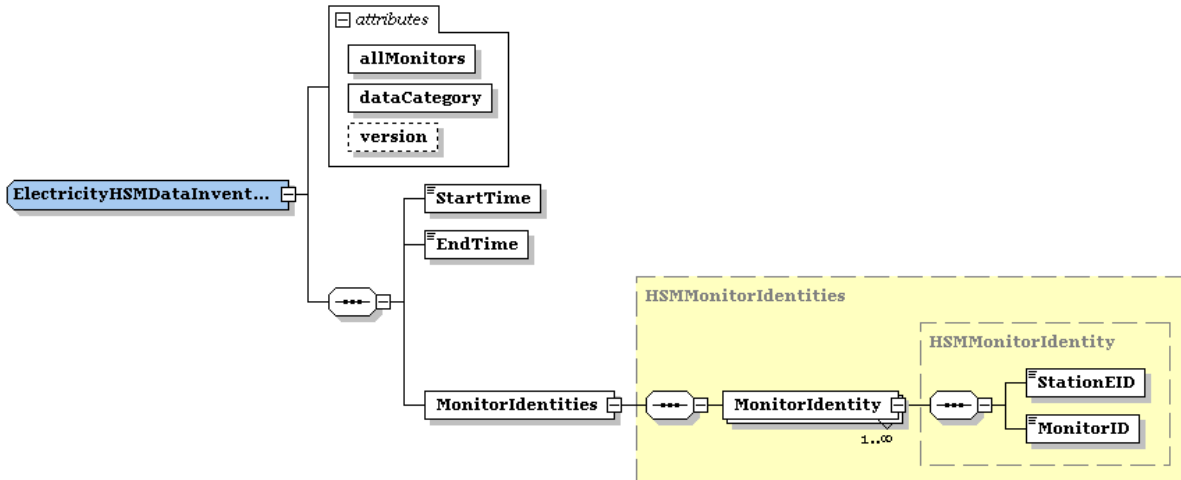

Figure 2-1 ElectricityHSMDDataInventoryRequestData

This allows us to query for any available data, of type dataCategory, from allMonitors or a specified list of one or more MonitorIdentity, between the MarketTime timestamps StartTime and EndTime. Our understanding is that the timestamp associated with a triggered data sample is the timestamp of the triggering fault-point within the sample, not the start timestamp of the recording. When selecting triggered data samples to return in a response message, the sample’s fault-point timestamp should lie between StartTime and EndTime.

The associated response transaction is the **HSMDDataInventoryResponse**. The payload of the response is the new data type, **ElectricityHSMDDataInventoryResponseData**.

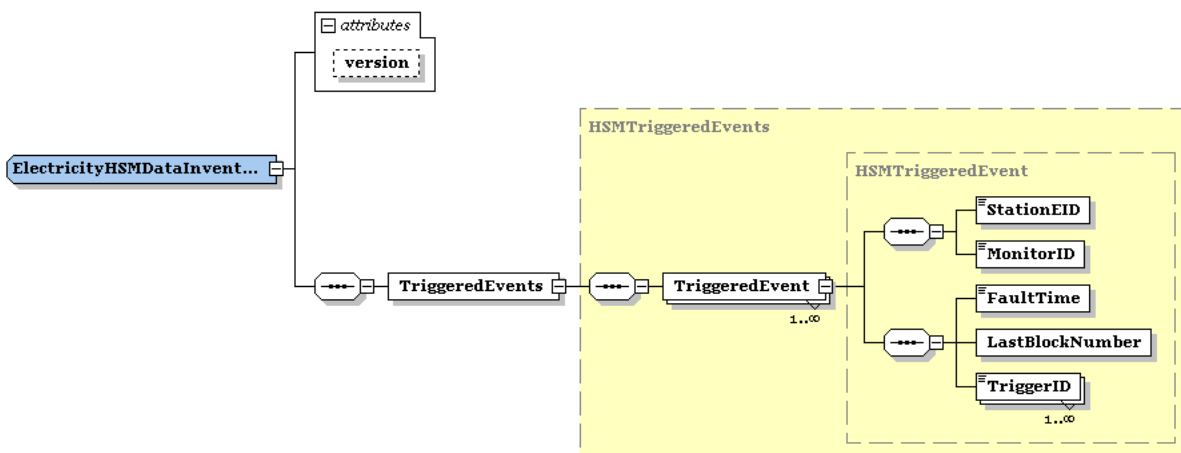

Figure 2-2 ElectricityHSMDDataInventoryResponseData

A “nil” TriggeredEvents element is returned if there are no data samples in the requested time period, or there is an error associated with the request. Otherwise, it contains a list of TriggeredEvent elements. Each of these:

- identifies the associated monitor (StationEID/MonitorID),
- the FaultTime within the sample (expressed in MarketTime),

- the LastBlockNumber. When the data sample in a TriggeredEvent exceeds 512kb in size, the data will be returned in blocks of size not exceeding 512kb. The COMTRADE content of any block will always be sized so that the first and last lines of data are complete lines of COMTRADE. When the data sample size is not an exact multiple of 512kb, the data will be divide into a series of zero or more 512kb blocks, with an odd-sized block as the last block of the series. LastBlockNumber is the index of the last block in the series. For example, if there is 321kb of data, LastBlockNumber=1 and its size is 321kb; if there is 923kb of data, LastBlockNumber=2, and its size is 923-512=411kb.
- and all the TriggerIDs (one or more) responsible for the recording of the data sample.

FaultTime is the timestamp of the triggering fault-point within the sample, not the start timestamp of the recording.

The TriggerID values uniquely identify Trigger elements returned in a HSMTriggersResponse transaction, described in the next section.

2.1.3.2 Retrieve details of triggers

The payload of the **HSMTriggersRequest** transaction is the new data type ElectricityHSMDataInventoryRequestData.

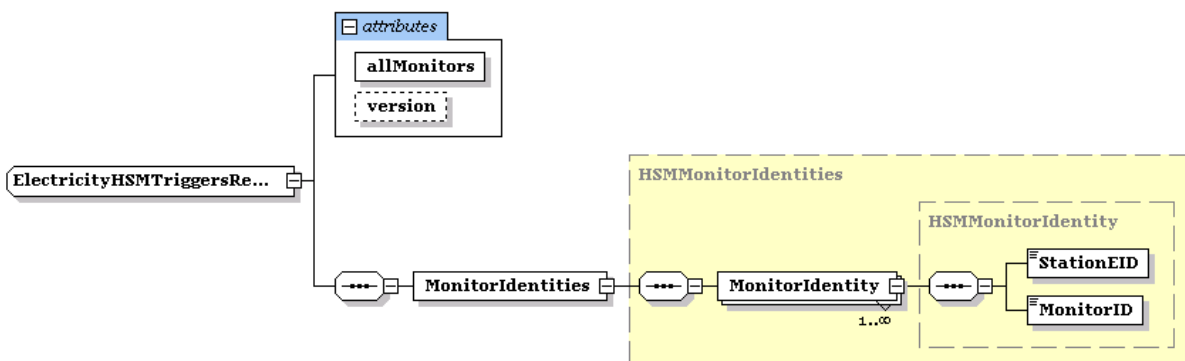

Figure 2-3 ElectricityHSMDataInventoryRequestData

This allows us to query for trigger (aka sensor) details, from allMonitors or a specified list of one or more MonitorIdentity.

The associated response transaction is the **HSMTriggersResponse**. The payload of the response is the new data type, ElectricityHSMTriggersResponseData.

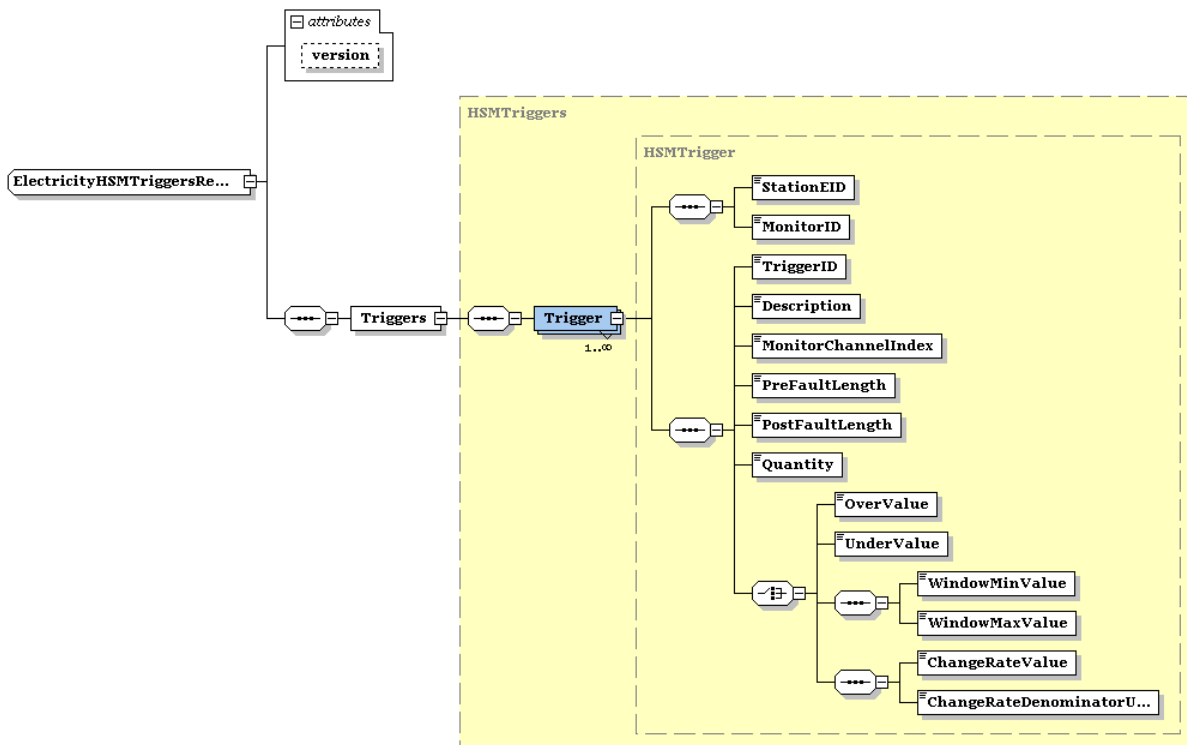

Figure 2-4 ElectricityHSMTriggersResponseData

A “nil” Triggers element is returned if there are no triggers defined for the specified monitors, or there is an error associated with the request. Otherwise, it contains a list of Trigger elements. Each of these:

- identifies the associated monitor (StationEID/MonitorID),
- has a unique alpha-numeric TriggerID,
- an optional Description,
- the MonitorChannelIndex associated with the trigger, being the same value as Index for the same MonitorChannel returned in a MonitorCapability element in a HSMMonitorsResponse transaction.
- PreFaultLength and PostFaultLength, are the lengths of data samples (seconds) recorded, respectively, before and after the fault point in any associated triggered data sample.
- Quantity is the physical quantity associated with the trigger. This value is of type HSMQuantity (expanded for r26) and must always be identical to the Quantity for the MonitorChannel in a MonitorCapability element in a HSMMonitorsResponse transaction.
- Following Quantity is the quantitative value for *_one_* kind of a possible set of trigger conditions. The measurement unit for the value must exactly match the SI unit for the associated MonitorChannel’s Quantity in a HSMMonitorDataResponse transaction
 - OverValue – an upper limit trigger condition
 - UnderValue – a lower limit trigger condition
 - WindowMinValue/WindowMaxValue – upper and lower bounds for an allowable range or window trigger condition
 - ChangeRateValue – an upper limit rate of change trigger condition – and ChangeRateDenominatorUnit – the SI measurement unit for the denominator quantity in the ChangeRate, typically “s” (seconds).

2.1.3.3 Retrieve triggered data

The payload of the **HSMMonitorDataRequest** transaction is the modified data type ElectricityHSMMonitorDataRequestData.

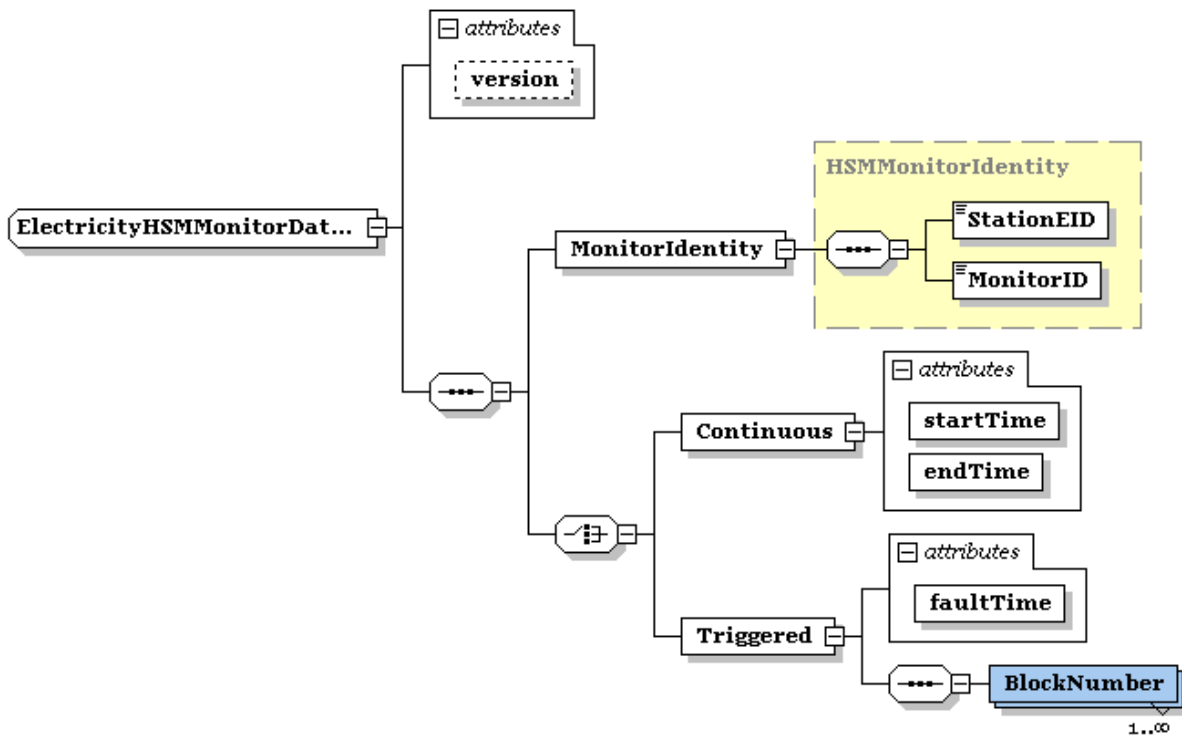

Figure 2-5 ElectricityHSMMonitorDataRequestData

The request can be for either Continuous or Triggered data, as indicated by the presence of the same-named element in the request.

The Continuous element has attributes of startTime and endTime to identify the requested sample end-points.

The Triggered element has an attribute of faultTime to identify the data sample as returned in an earlier HSMDDataInventoryResponse. The Triggered element has a series of 1 or more BlockNumber sub-elements that identify the requested blocks to be returned from within the data sample. This may not necessarily be the complete series from 1 to LastBlockNumber, and may not be sequential.

The version attribute has been revised to r26.

The associated response transaction is the **HSMMonitorDataResponse**. The payload of the response is the modified data type, ElectricityHSMMonitorDataResponseData.

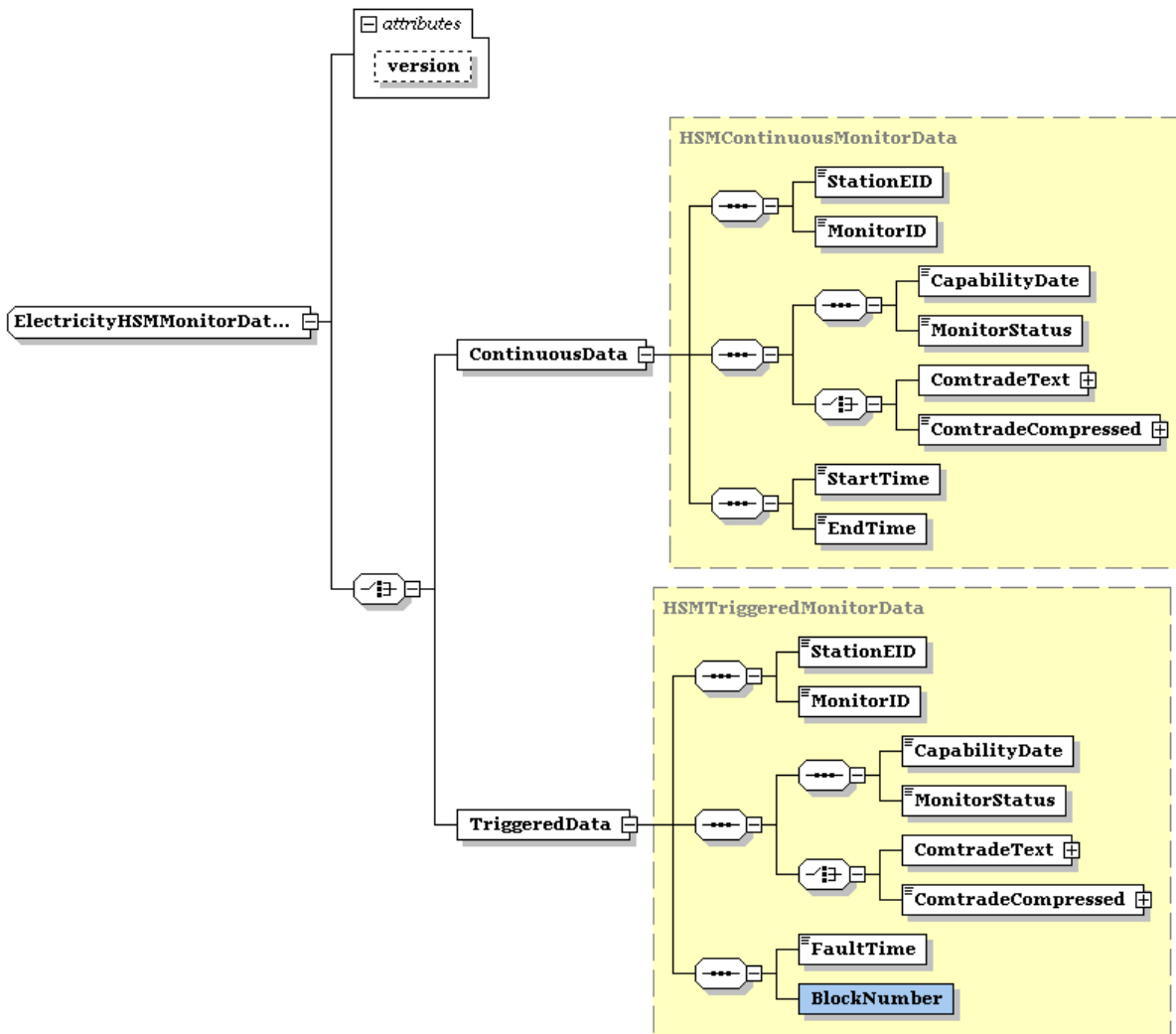

Figure 2-6 ElectricityHSMMonitorDataResponseData

The HSMMonitorData type has been sub-typed to

- HSMContinuousMonitorData, adding StartTime and EndTime elements,
- and HSMTriggeredMonitorData, adding FaultTime and BlockNumber, which identifies the returned block’s position in a series of 1 to LastBlockNumber blocks contained in the data sample, identified by StationEID, MonitorID and FaultTime.

The HSMComtradeText type has been extended to include an optional Header element of type NonZeroLengthString, similar to sibling elements Configuration and Data.

The version attribute has been revised to r26.

2.1.3.4 Retrieve triggered monitor capability

The payload of the **HSMMonitorsRequest** transaction is the modified data type ElectricityHSMMonitorsRequestData.

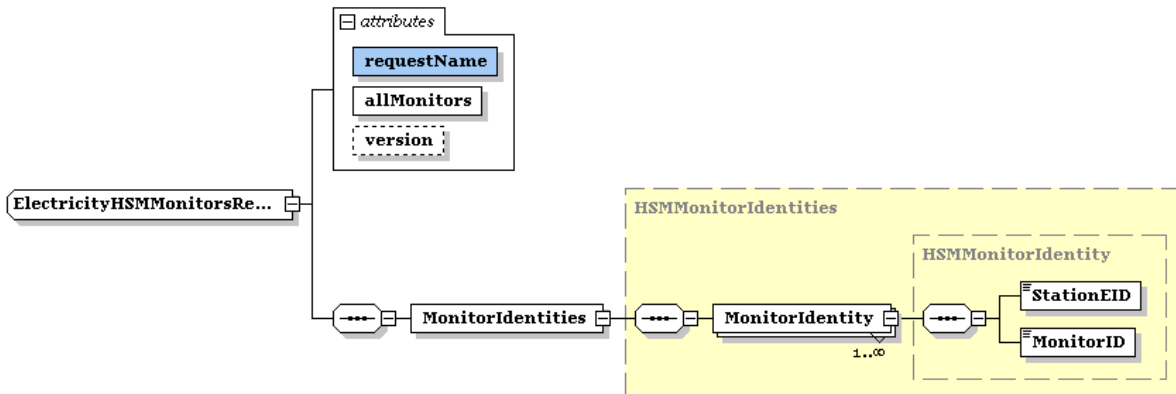

Figure 2-7 ElectricityHSMMonitorsRequestData

The attribute requestName is now of type HSMMonitors – RollCall, ContinuousCapability, TriggeredCapability or WaveformCapability. *There are no current plans to request WaveformCapability.*

The version attribute has been revised to r26.

The associated response transaction is the **HSMMonitorsResponse**. The payload of the response is the modified data type, ElectricityHSMMonitorsResponseData.

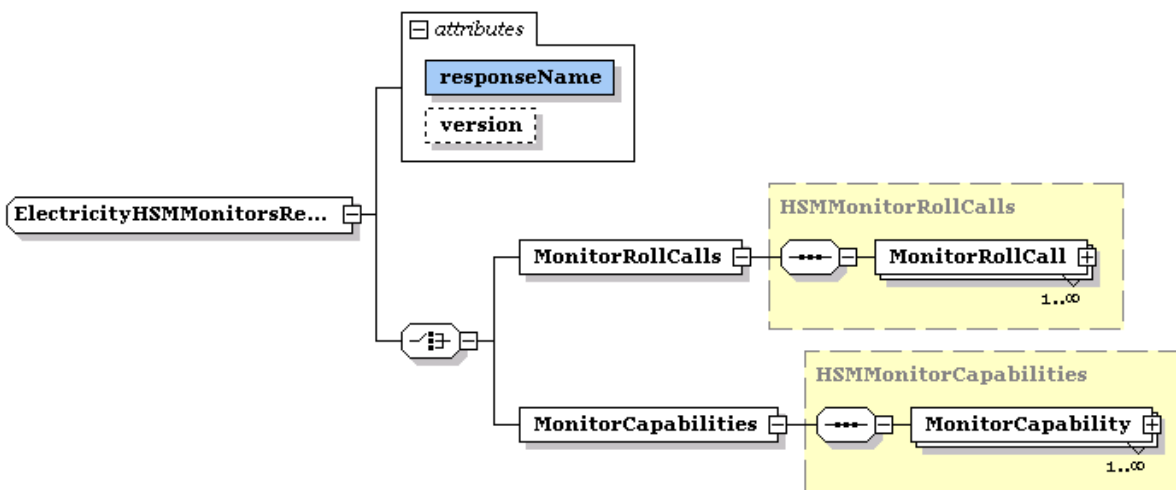

Figure 2-8 ElectricityHSMMonitorsResponseData

A new attribute responseName, of type HSMMonitors, has been added to disambiguate between the three different forms of monitor capability.

The version attribute has been revised to r26.

2.1.3.5 ElectricityHighSpeedMonitoring_r26.xsd

Text added is given in bold:

... unmodified text removed for brevity ...

```

<xsd:simpleType name="HSMID">
    <xsd:restriction base="NonZeroLengthString">
        <xsd:maxLength value="40"/>
        <xsd:pattern value="[A-Z0-9_]*"/>
    </xsd:restriction>
</xsd:simpleType>
    
```

```

<xsd:simpleType name="HSMTriggerID">
  <xsd:restriction base="NonZeroLengthString">
    <xsd:maxLength value="40"/>
    <xsd:pattern value="[A-Z0-9_]*"/>
  </xsd:restriction>
</xsd:simpleType>

```

```

<xsd:simpleType name="HSMPlant">

```

... unmodified text removed for brevity ...

```

<xsd:simpleType name="HSMQuantity">
  <xsd:restriction base="xsd:string">
    <xsd:enumeration value="Angle Blue"/>
    <xsd:enumeration value="Angle Positive Sequence"/>
    <xsd:enumeration value="Angle Red"/>
    <xsd:enumeration value="Angle White"/>
    <xsd:enumeration value="Voltage Angle Blue"/>
    <xsd:enumeration value="Voltage Angle Positive Sequence"/>
    <xsd:enumeration value="Voltage Angle Red"/>
    <xsd:enumeration value="Voltage Angle White"/>
    <xsd:enumeration value="Frequency"/>
    <xsd:enumeration value="Power Blue"/>
    <xsd:enumeration value="Power Red"/>
    <xsd:enumeration value="Power Three Phase"/>
    <xsd:enumeration value="Power White"/>
    <xsd:enumeration value="Reactive Power Blue"/>
    <xsd:enumeration value="Reactive Power Red"/>
    <xsd:enumeration value="Reactive Power Three Phase"/>
    <xsd:enumeration value="Reactive Power White"/>
    <xsd:enumeration value="Voltage Blue"/>
    <xsd:enumeration value="Voltage Positive Sequence"/>
    <xsd:enumeration value="Voltage Red"/>
    <xsd:enumeration value="Voltage White"/>
    <xsd:enumeration value="Current Red"/>
    <xsd:enumeration value="Current White"/>
    <xsd:enumeration value="Current Blue"/>
    <xsd:enumeration value="Current Angle Red"/>
    <xsd:enumeration value="Current Angle Blue"/>
    <xsd:enumeration value="Current Angle White"/>
  </xsd:restriction>

```

... unmodified text removed for brevity ...

```

<xsd:simpleType name="HSMSource">
  <xsd:simpleType name="HSMData">
    <xsd:restriction base="xsd:string">
      <xsd:enumeration value="Continuous"/>
      <xsd:enumeration value="Triggered"/>
      <xsd:enumeration value="Waveform"/>
    </xsd:restriction>

```

... unmodified text removed for brevity ...

```

<xsd:simpleType name="HSMTriggerValue">

```

```

                <xsd:restriction base="xsd:double"/>
            </xsd:simpleType>
... unmodified text removed for brevity ...
        <xsd:simpleType name="HSMMonitors">
            <xsd:restriction base="xsd:string">
                <xsd:enumeration value="RollCall"/>
                <xsd:enumeration value="ContinuousCapability"/>
                <xsd:enumeration value="TriggeredCapability"/>
                <xsd:enumeration value="WaveformCapability"/>
            </xsd:restriction>
        </xsd:simpleType>
... unmodified text removed for brevity ...
<xsd:complexType name="HSMMonitorData">
    <xsd:complexContent>
        <xsd:extension base="HSMMonitorIdentity">
            <xsd:sequence>
                <xsd:sequence>
                    <xsd:element name="CapabilityDate" type="xsd:dateTime"
nillable="false"/>
                    <xsd:element name="MonitorStatus" type="HSMStatus"/>
                </xsd:sequence>
                <xsd:choice>
                    <xsd:element name="ComtradeText" type="HSMComtradeText"
nillable="true"/>
                    <xsd:element name="ComtradeCompressed" nillable="true">
                        <xsd:complexType>
                            <xsd:simpleContent>
                                <xsd:extension base="xsd:base64Binary">
                                    <xsd:attribute name="format"
type="HSMCompression" use="required"/>
                                </xsd:extension>
                            </xsd:simpleContent>
                        </xsd:complexType>
                    </xsd:element>
                </xsd:choice>
            </xsd:sequence>
        </xsd:extension>
    </xsd:complexContent>
</xsd:complexType>
<xsd:complexType name="HSMContinuousMonitorData">
    <xsd:complexContent>
        <xsd:extension base="HSMMonitorData">
            <xsd:sequence>
                <xsd:element name="StartTime" type="xsd:dateTime"/>
                <xsd:element name="EndTime" type="xsd:dateTime"/>
            </xsd:sequence>
        </xsd:extension>
    </xsd:complexContent>
</xsd:complexType>
<xsd:complexType name="HSMTriggeredMonitorData">
    <xsd:complexContent>
        <xsd:extension base="HSMMonitorData">
            <xsd:sequence>
                <xsd:element name="FaultTime" type="xsd:dateTime"/>
                <xsd:element name="BlockNumber" type="ReplicationSequenceNumber"/>
            </xsd:sequence>
        </xsd:extension>
    </xsd:complexContent>
</xsd:complexType>
<xsd:complexType name="HSMComtradeText">
    <xsd:sequence>
        <xsd:element name="Header" type="NonZeroLengthString" nillable="true" minOccurs="0"/>
        <xsd:element name="Configuration" type="NonZeroLengthString" nillable="true"/>
        <xsd:element name="Data" type="NonZeroLengthString" nillable="true"/>
    </xsd:sequence>
</xsd:complexType>

```

```

<xsd:complexType name="HSMTriggeredEvents">
  <xsd:sequence>
    <xsd:element name="TriggeredEvent" type="HSMTriggeredEvent" maxOccurs="unbounded"/>
  </xsd:sequence>
</xsd:complexType>
<xsd:complexType name="HSMTriggeredEvent">
  <xsd:complexContent>
    <xsd:extension base="HSMMonitorIdentity">
      <xsd:sequence>
        <xsd:element name="FaultTime" type="xsd:dateTime"/>
        <xsd:element name="TriggerID" type="HSMTriggerID"
maxOccurs="unbounded"/>
      </xsd:sequence>
    </xsd:extension>
  </xsd:complexContent>
</xsd:complexType>
<xsd:complexType name="HSMTrigger">
  <xsd:complexContent>
    <xsd:extension base="HSMMonitorIdentity">
      <xsd:sequence>
        <xsd:element name="TriggerID" type="HSMTriggerID" nillable="false"/>
        <xsd:element name="Description" type="xsd:string" nillable="true"/>
        <xsd:element name="MonitorChannelIndex" nillable="false">
          <xsd:simpleType>
            <xsd:restriction base="xsd:positiveInteger">
              <xsd:totalDigits value="10"/>
            </xsd:restriction>
          </xsd:simpleType>
        </xsd:element>
        <xsd:element name="PreFaultLength" type="xsd:nonNegativeInteger"
nillable="false"/>
        <xsd:element name="PostFaultLength" type="xsd:nonNegativeInteger"
nillable="false"/>
        <xsd:element name="Quantity" type="HSMQuantity" nillable="false"/>
        <xsd:choice>
          <xsd:element name="OverValue" type="HSMTriggerValue"
nillable="false"/>
          <xsd:element name="UnderValue" type="HSMTriggerValue"
nillable="false"/>
        <xsd:sequence>
          <xsd:element name="WindowMinValue"
type="HSMTriggerValue" nillable="false"/>
          <xsd:element name="WindowMaxValue"
type="HSMTriggerValue" nillable="false"/>
        </xsd:sequence>
        <xsd:sequence>
          <xsd:element name="ChangeRateValue"
type="HSMTriggerValue" nillable="false"/>
          <xsd:element name="ChangeRateDenominatorUnit"
type="xsd:string" nillable="false"/>
        </xsd:sequence>
      </xsd:extension>
    </xsd:sequence>
  </xsd:complexContent>
</xsd:complexType>

```

```

                </xsd:choice>
            </xsd:sequence>
            <xsd:attribute name="lastUpdated" type="xsd:dateTime" use="required"/>
        </xsd:extension>
    </xsd:complexContent>
</xsd:complexType>
<xsd:complexType name="HSMTriggers">
    <xsd:sequence>
        <xsd:element name="Trigger" type="HSMTrigger" maxOccurs="unbounded"/>
    </xsd:sequence>
</xsd:complexType>
<!--concrete transaction payload types-->
    <xsd:complexType name="ElectricityHSMMonitorDataRequestData">
        <xsd:complexContent>
            <xsd:extension base="HSMMonitorDataRequestData">
                <xsd:sequence>
                    <xsd:choice>
                        <xsd:element name="MonitorIdentity" type="HSMMonitorIdentity"/>
                        <xsd:element name="AllMonitors">
                            <xsd:simpleType>
                                <xsd:restriction base="xsd:boolean">
                                    <xsd:pattern value="true"/>
                                </xsd:restriction>
                            </xsd:simpleType>
                        </xsd:element>
                    </xsd:choice>
                    <xsd:element name="StartTime" type="xsd:dateTime"/>
                    <xsd:element name="EndTime" type="xsd:dateTime"/>
                </xsd:sequence>
                <xsd:attribute name="dataCategory" use="optional" default="ContinuousData">
                    <xsd:simpleType>
                        <xsd:restriction base="xsd:string">
                            <xsd:enumeration value="ContinuousData"/>
                            <xsd:enumeration value="TriggeredData"/>
                        </xsd:restriction>
                    </xsd:simpleType>
                </xsd:attribute>
                <xsd:attribute name="version" type="r24" default="r24"/>
            </xsd:extension>
        </xsd:complexContent>
    </xsd:complexType>
<xsd:complexType name="ElectricityHSMMonitorDataRequestData">
    <xsd:complexContent>
        <xsd:extension base="HSMMonitorDataRequestData">
            <xsd:sequence>
                <xsd:element name="MonitorIdentity" type="HSMMonitorIdentity"/>
                <xsd:choice>

```



```

        <xsd:element name="Continuous">
            <xsd:complexType>
                <xsd:attribute name="startTime"
type="xsd:dateTime" use="required"/>
                <xsd:attribute name="endTime"
type="xsd:dateTime" use="required"/>
            </xsd:complexType>
        </xsd:element>
        <xsd:element name="Triggered">
            <xsd:complexType>
                <xsd:sequence>
                    <xsd:element name="BlockNumber"
type="ReplicationSequenceNumber" maxOccurs="unbounded"/>
                </xsd:sequence>
                <xsd:attribute name="faultTime"
type="xsd:dateTime" use="required"/>
            </xsd:complexType>
        </xsd:element>
    </xsd:choice>
</xsd:sequence>
    <xsd:attribute name="version" type="r26" use="optional" default="r26"/>
</xsd:extension>
</xsd:complexContent>
</xsd:complexType>
<xsd:complexType name="ElectricityHSMMonitorDataResponseData">
    <xsd:complexContent>
        <xsd:extension base="HSMMonitorDataResponseData">
            <xsd:sequence>
                <xsd:choice>
                    <xsd:element name="ContinuousData" type="HSMMonitorData"
nillable="true"/>
                    <xsd:element name="TriggeredData" type="HSMMonitorData"
nillable="true"/>
                </xsd:choice>
            </xsd:sequence>
            <xsd:attribute name="version" type="r24" default="r24"/>
        </xsd:extension>
    </xsd:complexContent>
</xsd:complexType>
<xsd:complexType name="ElectricityHSMMonitorsRequestData">
    <xsd:complexContent>
        <xsd:extension base="HSMMonitorsRequestData">
            <xsd:sequence>
                <xsd:element name="MonitorIdentities" type="HSMMonitorIdentities" nillable="true"/>
            </xsd:sequence>
            <xsd:attribute name="requestName" use="required">
                <xsd:simpleType>
                    <xsd:restriction base="xsd:string">
                        <xsd:enumeration value="RollCall"/>
                        <xsd:enumeration value="Capability"/>
                    </xsd:restriction>
                </xsd:simpleType>
            </xsd:attribute>
        </xsd:extension>
    </xsd:complexContent>
</xsd:complexType>

```

```

</xsd:restriction>
</xsd:simpleType>
</xsd:attribute>
<xsd:attribute name="allMonitors" type="xsd:boolean" use="required"/>
<xsd:attribute name="version" type="r21" default="r21"/>
</xsd:extension>
</xsd:complexContent>
</xsd:complexType>
<xsd:complexType name="ElectricityHSMMonitorsResponseData">
  <xsd:complexContent>
    <xsd:extension base="HSMMonitorsResponseData">
      <xsd:choice>
        <xsd:element name="MonitorRollCalls" type="HSMMonitorRollCalls" nillable="true"/>
        <xsd:element name="MonitorCapabilities" type="HSMMonitorCapabilities"
nillable="true"/>
      </xsd:choice>
      <xsd:attribute name="version" type="r21" default="r21"/>
    </xsd:extension>
  </xsd:complexContent>
</xsd:complexType>
<xsd:complexType name="ElectricityHSMTTriggeredDataNotificationData">
  <xsd:complexContent>
    <xsd:extension base="HSMTTriggeredDataNotificationData">
      <xsd:sequence>
        <xsd:element name="TriggeredData" type="HSMMonitorData" nillable="true"/>
      </xsd:sequence>
      <xsd:attribute name="version" type="r23" default="r23"/>
    </xsd:extension>
  </xsd:complexContent>
</xsd:complexType>
<xsd:complexType name="ElectricityHSMMonitorDataResponseData">
  <xsd:complexContent>
    <xsd:extension base="HSMMonitorDataResponseData">
      <xsd:choice>
        <xsd:element name="ContinuousData" type="HSMContinuousMonitorData"
nillable="true"/>
        <xsd:element name="TriggeredData" type="HSMTTriggeredMonitorData"
nillable="true"/>
      </xsd:choice>
      <xsd:attribute name="version" type="r26" use="optional" default="r26"/>
    </xsd:extension>
  </xsd:complexContent>
</xsd:complexType>
<xsd:complexType name="ElectricityHSMMonitorsRequestData">
  <xsd:complexContent>
    <xsd:extension base="HSMMonitorsRequestData">
      <xsd:sequence>
        <xsd:element name="MonitorIdentities" type="HSMMonitorIdentities"
nillable="true"/>

```

```

        </xsd:sequence>
        <xsd:attribute name="requestName" type="HSMMonitors" use="required"/>
        <xsd:attribute name="allMonitors" type="xsd:boolean" use="required"/>
        <xsd:attribute name="version" type="r26" use="optional" default="r26"/>
    </xsd:extension>
</xsd:complexContent>
</xsd:complexType>
<xsd:complexType name="ElectricityHSMMonitorsResponseData">
    <xsd:complexContent>
        <xsd:extension base="HSMMonitorsResponseData">
            <xsd:choice>
                <xsd:element name="MonitorRollCalls" type="HSMMonitorRollCalls"
nillable="true"/>
                <xsd:element name="MonitorCapabilities" type="HSMMonitorCapabilities"
nillable="true"/>
            </xsd:choice>
            <xsd:attribute name="responseName" type="HSMMonitors" use="required"/>
            <xsd:attribute name="version" type="r26" use="optional" default="r26"/>
        </xsd:extension>
    </xsd:complexContent>
</xsd:complexType>
<xsd:complexType name="ElectricityHSMDDataInventoryRequestData">
    <xsd:complexContent>
        <xsd:extension base="HSMDDataInventoryRequestData">
            <xsd:sequence>
                <xsd:element name="StartTime" type="xsd:dateTime"/>
                <xsd:element name="EndTime" type="xsd:dateTime"/>
                <xsd:element name="MonitorIdentities" type="HSMMonitorIdentities"
nillable="true"/>
            </xsd:sequence>
            <xsd:attribute name="allMonitors" type="xsd:boolean" use="required"/>
            <xsd:attribute name="dataCategory" type="HSMDData" use="required"/>
            <xsd:attribute name="version" type="r26" use="optional" default="r26"/>
        </xsd:extension>
    </xsd:complexContent>
</xsd:complexType>
<xsd:complexType name="ElectricityHSMDDataInventoryResponseData">
    <xsd:complexContent>
        <xsd:extension base="HSMDDataInventoryResponseData">
            <xsd:sequence>
                <xsd:element name="TriggeredEvents" type="HSMTriggeredEvents"
nillable="true"/>
            </xsd:sequence>
            <xsd:attribute name="version" type="r26" use="optional" default="r26"/>
        </xsd:extension>
    </xsd:complexContent>
</xsd:complexType>
<xsd:complexType name="ElectricityHSMTriggersRequestData">
    <xsd:complexContent>

```

```

        <xsd:extension base="HSMTriggersRequestData">
            <xsd:sequence>
                <xsd:element name="MonitorIdentities" type="HSMMonitorIdentities"
nillable="true"/>
            </xsd:sequence>
            <xsd:attribute name="allMonitors" type="xsd:boolean" use="required"/>
            <xsd:attribute name="version" type="r26" use="optional" default="r26"/>
        </xsd:extension>
    </xsd:complexContent>
</xsd:complexType>
<xsd:complexType name="ElectricityHSMTriggersResponseData">
    <xsd:complexContent>
        <xsd:extension base="HSMTriggersResponseData">
            <xsd:sequence>
                <xsd:element name="Triggers" type="HSMTriggers" nillable="true"/>
            </xsd:sequence>
            <xsd:attribute name="version" type="r26" use="optional" default="r26"/>
        </xsd:extension>
    </xsd:complexContent>
</xsd:complexType>
</xsd:schema>

```

2.1.3.6 HighSpeedMonitoring_r26.xsd

Text added is given in bold:

```

<?xml version="1.0" encoding="UTF-8"?>
<xsd:schema xmlns:xsd="http://www.w3.org/2001/XMLSchema" elementFormDefault="unqualified" attributeFormDefault="unqualified">
    <xsd:simpleType name="HSMVendorSoftwareVersion">
        <xsd:annotation>
            <xsd:documentation>Purpose - Tracks the software version installed at a given
TNSP.</xsd:documentation>
        </xsd:annotation>
        <xsd:restriction base="xsd:string">
            <xsd:maxLength value="80"/>
        </xsd:restriction>
    </xsd:simpleType>
    <!--transaction types-->
    <xsd:complexType name="HSMMonitorDataRequest">
        <xsd:sequence>
            <xsd:element name="RequestData" type="HSMMonitorDataRequestData"/>
        </xsd:sequence>
        <xsd:attribute name="version" type="r21" default="r21"/>
    </xsd:complexType>
    <xsd:complexType name="HSMMonitorDataResponse">
        <xsd:sequence>
            <xsd:element name="ResponseData" type="HSMMonitorDataResponseData"/>
            <xsd:element name="Event" type="Event"/>
        </xsd:sequence>

```

```
<xsd:attribute name="vendorSoftwareVersion" type="HSMVendorSoftwareVersion" use="required"/>
<xsd:attribute name="version" type="r21" default="r21"/>
<xsd:attribute name="version" type="r26" default="r26"/>
</xsd:complexType>
<xsd:complexType name="HSMDataInventoryRequest">
  <xsd:sequence>
    <xsd:element name="RequestData" type="HSMDataInventoryRequestData"/>
  </xsd:sequence>
  <xsd:attribute name="version" type="r26" default="r26"/>
</xsd:complexType>
<xsd:complexType name="HSMDataInventoryResponse">
  <xsd:sequence>
    <xsd:element name="ResponseData" type="HSMDataInventoryResponseData"/>
    <xsd:element name="Event" type="Event"/>
  </xsd:sequence>
  <xsd:attribute name="vendorSoftwareVersion" type="HSMVendorSoftwareVersion" use="required"/>
  <xsd:attribute name="version" type="r26" default="r26"/>
</xsd:complexType>
<xsd:complexType name="HSMTriggersRequest">
  <xsd:sequence>
    <xsd:element name="RequestData" type="HSMTriggersRequestData"/>
  </xsd:sequence>
  <xsd:attribute name="version" type="r26" default="r26"/>
</xsd:complexType>
<xsd:complexType name="HSMTriggersResponse">
  <xsd:sequence>
    <xsd:element name="ResponseData" type="HSMTriggersResponseData"/>
    <xsd:element name="Event" type="Event"/>
  </xsd:sequence>
  <xsd:attribute name="vendorSoftwareVersion" type="HSMVendorSoftwareVersion" use="required"/>
  <xsd:attribute name="version" type="r26" default="r26"/>
</xsd:complexType>
<xsd:complexType name="HSMMonitorsRequest">
  <xsd:sequence>
    <xsd:element name="RequestData" type="HSMMonitorsRequestData"/>
  </xsd:sequence>
  <xsd:attribute name="version" type="r21" default="r21"/>
</xsd:complexType>
<xsd:complexType name="HSMMonitorsResponse">
  <xsd:sequence>
    <xsd:element name="ResponseData" type="HSMMonitorsResponseData"/>
    <xsd:element name="Event" type="Event"/>
  </xsd:sequence>
  <xsd:attribute name="vendorSoftwareVersion" type="HSMVendorSoftwareVersion" use="required"/>
  <xsd:attribute name="version" type="r26" default="r26"/>
</xsd:complexType>
</xsd:complexType>
```

```

<xsd:complexType name="HSMTriggeredDataNotification">
  <xsd:sequence>
    <xsd:element name="NotificationData" type="HSMTriggeredDataNotificationData"/>
  </xsd:sequence>
  <xsd:attribute name="version" type="r21" default="r21"/>
</xsd:complexType>
<!--transaction payload definitions-->
<xsd:complexType name="HSMMonitorDataRequestData" abstract="true"/>
<xsd:complexType name="HSMMonitorDataResponseData" abstract="true"/>
<xsd:complexType name="HSMDataInventoryRequestData" abstract="true"/>
<xsd:complexType name="HSMDataInventoryResponseData" abstract="true"/>
<xsd:complexType name="HSMTriggersRequestData" abstract="true"/>
<xsd:complexType name="HSMTriggersResponseData" abstract="true"/>
<xsd:complexType name="HSMMonitorsRequestData" abstract="true"/>
<xsd:complexType name="HSMMonitorsResponseData" abstract="true"/>
<xsd:complexType name="HSMTriggeredDataNotificationData" abstract="true"/>
</xsd:schema>

```

2.1.3.7 Events_r26.xsd

Text added is given in bold:

```

<xsd:simpleType name="r25">
  <xsd:annotation>
    <xsd:documentation>Purpose - Release r25 identifier</xsd:documentation>
  </xsd:annotation>
  <xsd:restriction base="ReleaseIdentifier">
    <xsd:enumeration value="r25"/>
  </xsd:restriction>
</xsd:simpleType>

<xsd:simpleType name="r26">
  <xsd:annotation>
    <xsd:documentation>Purpose - Release r26 identifier</xsd:documentation>
  </xsd:annotation>
  <xsd:restriction base="ReleaseIdentifier">
    <xsd:enumeration value="r26"/>
  </xsd:restriction>
</xsd:simpleType>

.....
<xsd:simpleType name="EventKeyInfo">
  <xsd:annotation>
    <xsd:documentation>
      Purpose - Provide information to allow identification of the data that triggered the event
      Detail - Where the combination of class and code are insufficient to completely describe an event, KeyInfo may be used to provide
      further detail as to the information needed to locate the source of the event within the original transaction.
    </xsd:documentation>
  </xsd:annotation>
  <xsd:restriction base="xsd:string">
    <xsd:maxLength value="80"/>
  </xsd:restriction>
</xsd:simpleType>

```

```

</xsd:restriction>
<xsd:restriction base="xsd:string"/>
</xsd:simpleType>

```

2.1.3.8 aseXML_r26.xsd

Text added is given in bold:

Add new include elements for **ElectricityHighSpeedMonitoring_r26.xsd** to schema element. Added text is bolded. Deleted text is bolded with strikethrough.

```

<?xml version="1.0" encoding="UTF-8"?>
<xsd:schema xmlns="urn:aseXML:r24" xmlns:xsd="http://www.w3.org/2001/XMLSchema" targetNamespace="urn:aseXML:r24">
  <xsd:annotation>
    <xsd:documentation>

```

Purpose — Top level aseXML schema

... unmodified text removed for brevity ...

```

</xsd:documentation>
</xsd:annotation>
<xsd:include schemaLocation="Events_r25.xsd">
<xsd:include schemaLocation="Events_r26.xsd">
  <xsd:annotation>
    <xsd:documentation>

```

Purpose — Include data types for status reporting

```

</xsd:documentation>
</xsd:annotation>
</xsd:include>

```

... unmodified text removed for brevity ...

```

</xsd:annotation>
</xsd:include>
<xsd:include schemaLocation="ElectricityHighSpeedMonitoring_r24.xsd">
<xsd:include schemaLocation="ElectricityHighSpeedMonitoring_r26.xsd">

```

```

  <xsd:annotation>
    <xsd:documentation>

```

Purpose — Include Electricity market data types for HSM transactions

... unmodified text removed for brevity ...

```

<xsd:include schemaLocation="HighSpeedMonitoring_r21.xsd">
<xsd:include schemaLocation="HighSpeedMonitoring_r26.xsd">

```

```

  <xsd:annotation>
    <xsd:documentation>

```

Purpose - Include data types for HSM transactions

```

</xsd:documentation>
</xsd:annotation>
</xsd:include>

```

```

<xsd:include schemaLocation="ElectricityHighSpeedMonitoring_r24.xsd">
<xsd:include schemaLocation="ElectricityHighSpeedMonitoring_r26.xsd">

```

```

  <xsd:annotation>
    <xsd:documentation>

```

Purpose - Include Electricity market data types for HSM transactions

```

</xsd:documentation>
</xsd:annotation>
</xsd:include>

```

```

<xsd:include schemaLocation="Transactions_r25.xsd">
<xsd:include schemaLocation="Transactions_r26.xsd">

```

```

  <xsd:annotation>
    <xsd:documentation>

```

Purpose - Include data types for carrying transactions within aseXML

```

</xsd:documentation>
</xsd:annotation>
</xsd:include>

```

... unmodified text removed for brevity ...

2.1.3.9 Transaction_r26.xsd

Text added is given in bold:

```
<xsd:element name="HSMMonitorsResponse" type="HSMMonitorsResponse"/>
    <xsd:element name="HSMMonitorDataRequest" type="HSMMonitorDataRequest"/>
    <xsd:element name="HSMMonitorDataResponse" type="HSMMonitorDataResponse"/>
    <xsd:element name="HSMTriggeredDataNotification" type="HSMTriggeredDataNotification"/>
    <xsd:element name="HSMDataInventoryRequest" type="HSMDataInventoryRequest"/>
    <xsd:element name="HSMDataInventoryResponse" type="HSMDataInventoryResponse"/>
    <xsd:element name="HSMTriggersRequest" type="HSMTriggersRequest"/>
    <xsd:element name="HSMTriggersResponse" type="HSMTriggersResponse"/>
    <xsd:element name="OneWayNotification" type="OneWayNotification"/>
</xsd:choice>
<xsd:attribute name="transactionID" type="TransactionIdentifier" use="required"/>
```

2.1.4 Impact Summary

This table identifies the files, transactions and versioned types that are potentially impacted as the result of these changes, where:

- Modified types - is a full list of types changed by this Change Request
- Derived types – is a list of any types that are derived from a modified type, and are therefore also modified by default
- Versioned types affected – is a list of all versioned types that will need to have the version attribute updated as a result of this Change Request
- Transactions potentially affected – is a list of all transactions that contain a modified type, either directly or via a type substitution
- Schema files affected – is a list of schema files that will be changed in some way as a result of this Change Request.

Modified types	Derived types	Versioned types affected	Transactions potentially affected	Schema files affected
Modified simple type: HSMQuantity, HSMDData Modified complex types: HSMMonitorData, HSMComtradeText , ElectricityHSMMonitorDataRequestData, ElectricityHSMMonitorDataResponseData, ElectricityHSMMonitorsRequestData, ElectricityHSMMonitorsResponseData		ElectricityHSMMonitorDataRequestData ElectricityHSMMonitorDataResponseData, ElectricityHSMMonitorsRequestData, ElectricityHSMMonitorsResponseData,	HSMTTriggeredDataResponse, HSMContinuousDataResponse, HSMMonitorDataRequest, HSMMonitorDataResponse,	ElectricityHighSpeedMonitoring_r26.xsd

Table 2-2, Impact Summary

2.1.5 Developer Test

2.1.5.1 Test Platforms

The new schema has been tested using the following platforms as advised by ASWG:

- XMLSpy 2010
- MSXML4 SP1, 6
- Xerces 2.2.1 and 2.9.1

2.1.5.2 Test Cases

capability.all.hsmdm_hsm_20100623130111082.xml
capability.normal.hsmdm_gpupp_20090605080627771.xml
capability.selective.hsmdm_hsm_20100623130130488.xml
data.hsmdl_hsm_20100623130203146.xml
data.normal.hsmdl_gpupp_20090605085007516.xml
inventory.all.hsmdh_hsm_20100623130009674.xml
inventory.normal.hsmdh_gpupp_20090605074826298.xml
inventory.selective.hsmdh_hsm_20100623130032174.xml
rollcall.all.hsmdh_hsm_20100623130009674.xml
rollcall.normal.hsmdh_gpupp_20090605074826298.xml
rollcall.selective.hsmdh_hsm_20100623130032174.xml
triggers.all.hsmdm_hsm_20100623130111082.xml
triggers.normal.hsmdm_gpupp_20090605080627771.xml
triggers.selective.hsmdm_hsm_20100623130130488.xml

3 Proposal Assessment

3.1 Test

The ASWG ensures that all recommended parsers on relevant platforms can successfully validate the proposed schema.

3.1.1 Test Platforms

Supplied samples have been tested using the following parsers:

- MSXML 4.0 SP1 (Schema was also validated using proposed MSXML 6.0)
- Xerces 1.4.4 and 2.2.1, (Schema was also validated using proposed Xerces 2.9.1)
- XMLSpy 2010 (XML Spy 2010 was used as XML Spy 2004 was unavailable)

3.1.2 Test Cases

Samples have been tested as per section 2.1.5.2.

3.1.3 Test Results

All OK.

3.2 Conformance Report

The ASWG completes the conformance report validating each proposed new schema file against the published aseXML guidelines.

Schema Filename	Impacted by Item #	Conformance Details
aseXML_r26.xsd	1	Conforms except Xerces 1.4.4
ElectricityHighSpeedMonitoring_r26.xsd	1	Conforms except Xerces 1.4.4
Events_r26.xsd	1	Conforms except Xerces 1.4.4
Transactions_r26.xsd	1	Conforms except Xerces 1.4.4
HighSpeedMonitoring_r26.xsd	1	Conforms except Xerces 1.4.4

Table 3-1, Change Proposal Conformance Details

4 Issue Register

This section describes any issues that have arisen and any modifications that are made to the original proposal during the Change Process

4.1 Status of Issues

Issue#	Item#	Description and Discussion	Status ³	Resolution
1	1	Initial test suggested that the schema is not valid on Xerces 1.4.4	Open	ASWG may reconsider supporting Xerces 1.4.4. There is already an action item with ASWG to consider replacing Xerces 1.4.4 with 2.9.1.

Table 4-1, Issues list

5 Resolution

The ASWG votes for endorsement of the options identified in section 2, and the voting results are forwarded to AEMO for approval. When 75% of those ASWG members who voted endorse a specific option, this represents an ASWG Recommendation for that option. AEMO will not reject an ASWG Recommendation without first consulting with the ASWG.

5.1 ASWG Endorsement

The results of the ASWG vote are as follows:

Date of Vote:??/??/????

Option	# Votes	% Vote
Option 1 (section 2.1)		
Option 2 (section 2.2)		
Option # (section 2.#)		

³ Either 'Open' or 'Closed'

Abstained		
Total Members Present		

Table 5-1, ASWG Vote Results